

SC-02 INTERNAL DIMENSIONS

FRONT DOOR
APERTURE

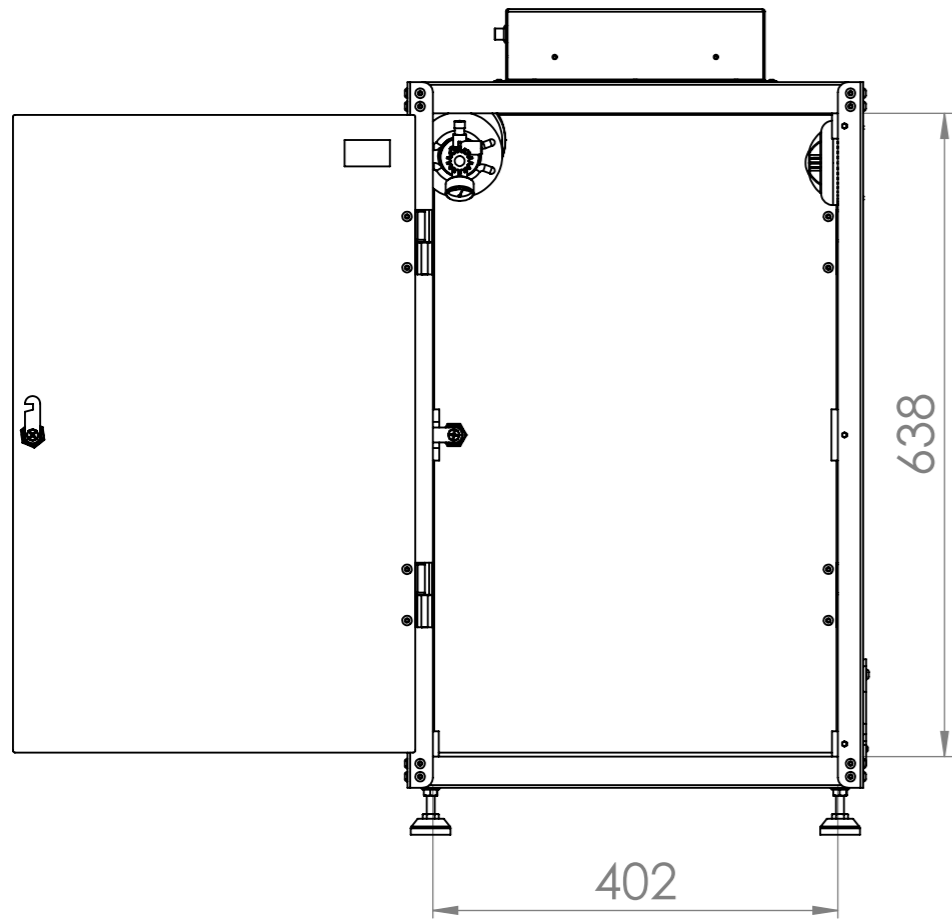

ALARM/EXTINGUISHER
LOCATIONS

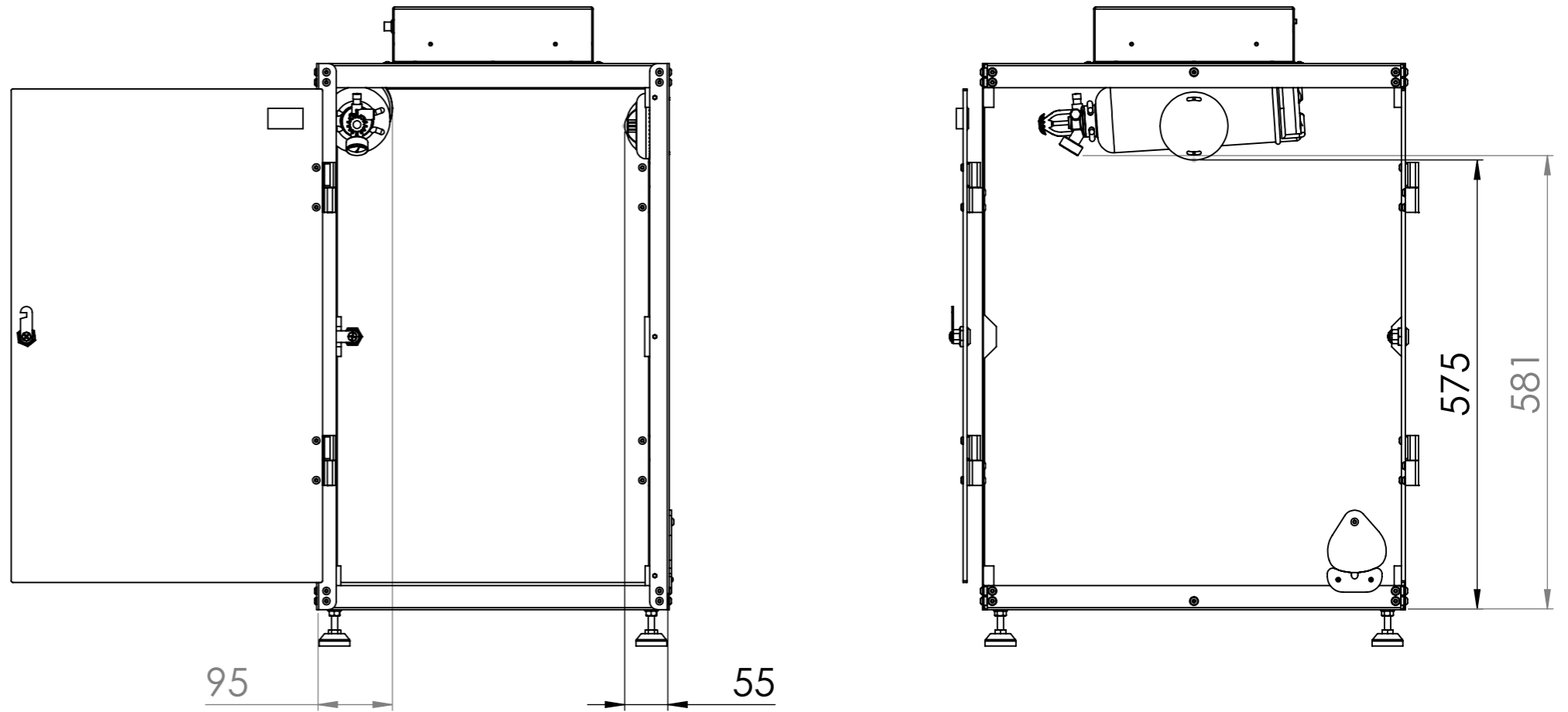

MAXIMUM
FOOTPRINT

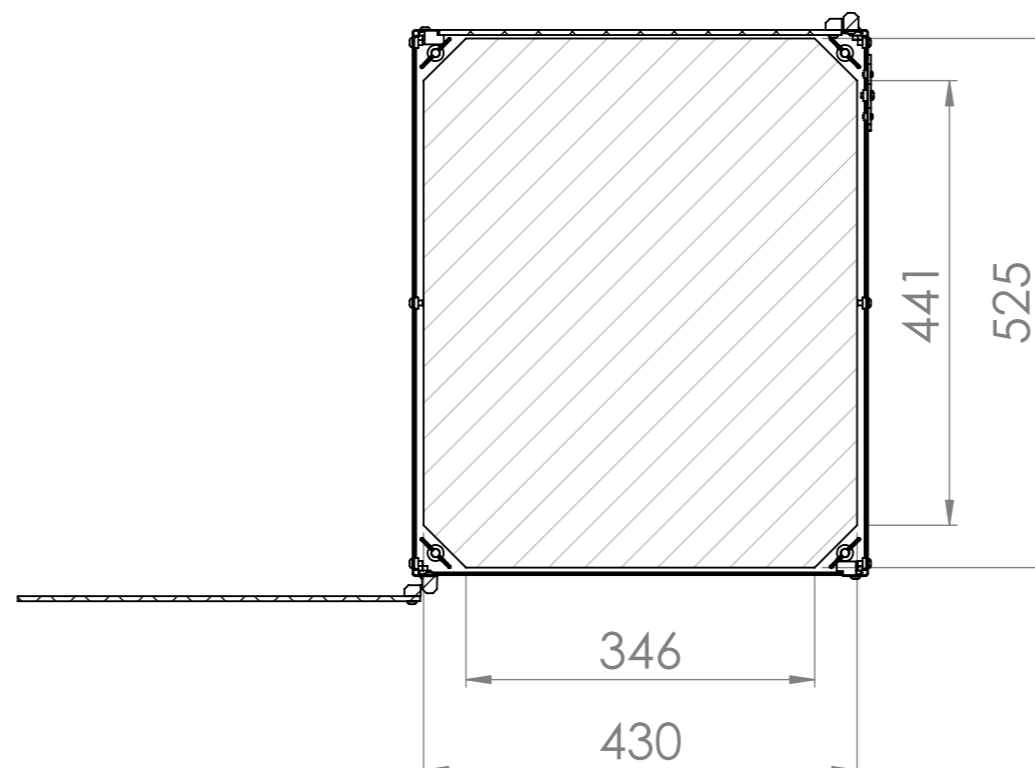

SECTION A-A

